

# KL-20 主管桌 安装图

①

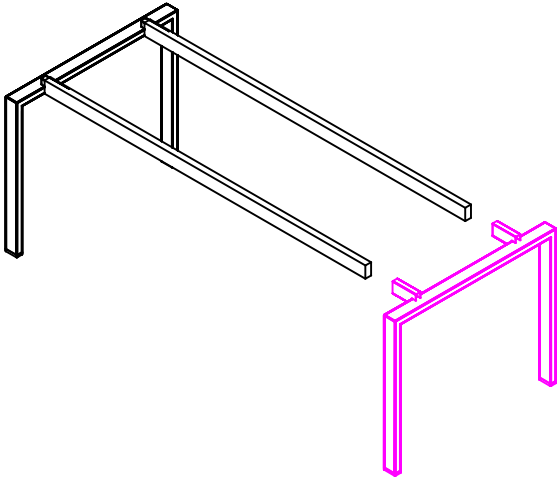

②

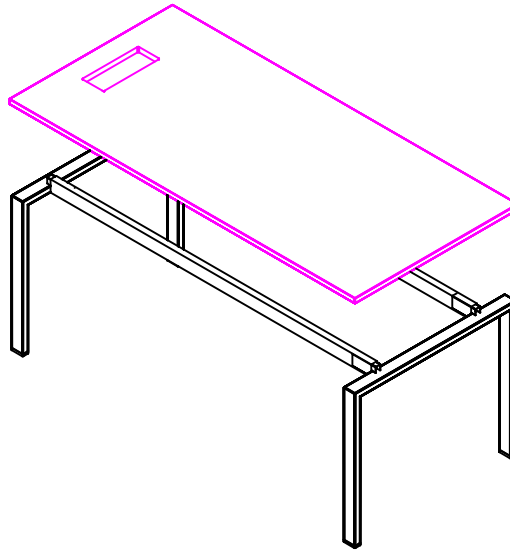

③

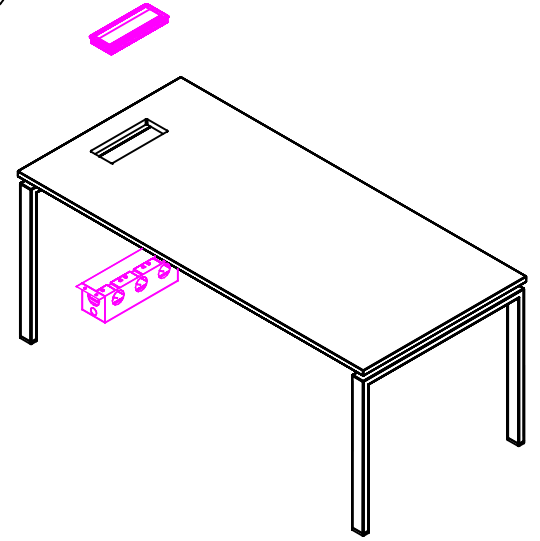

④

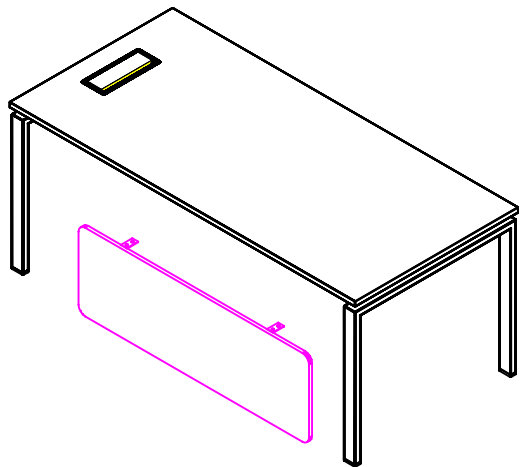

⑤

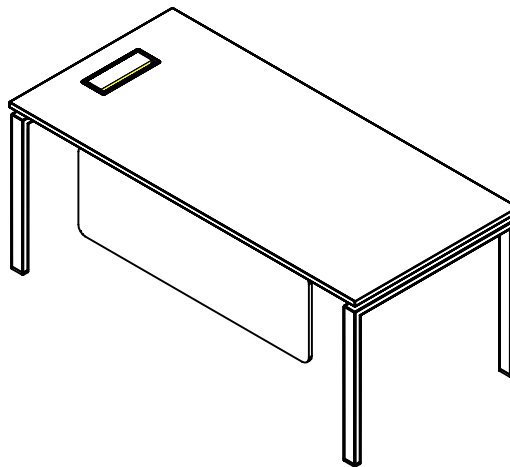

1. 钢脚/拉梁连接
2. 面板与钢架连接
3. 安装线盖及底盒
4. 安装挡板