

# KL-42 职员桌 安装图

①

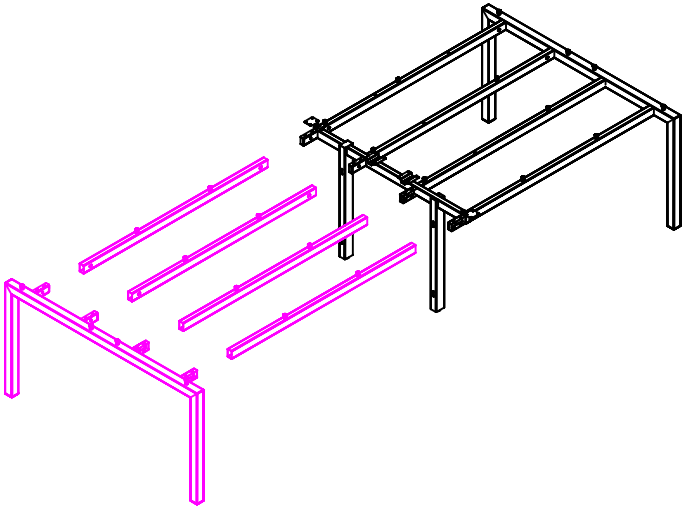

②

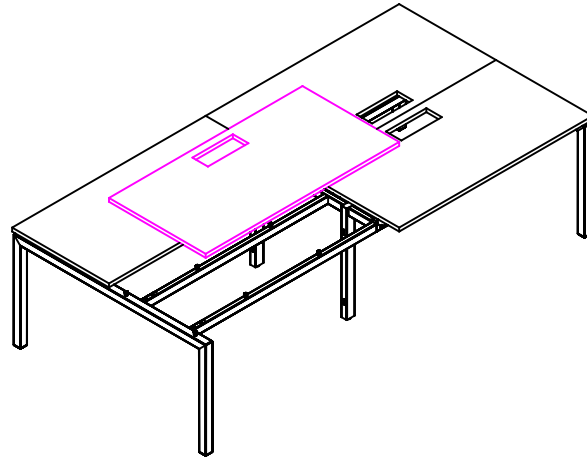

③

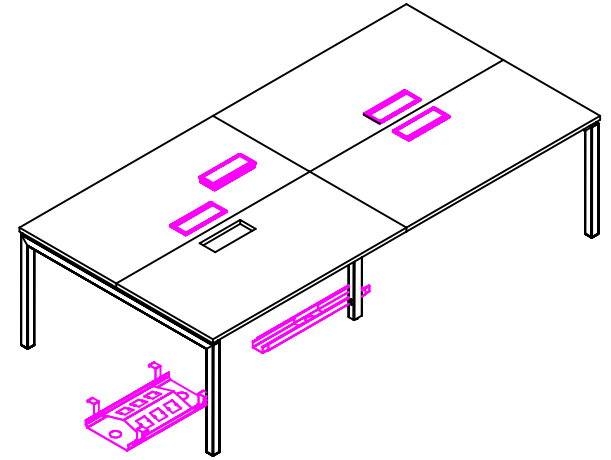

④

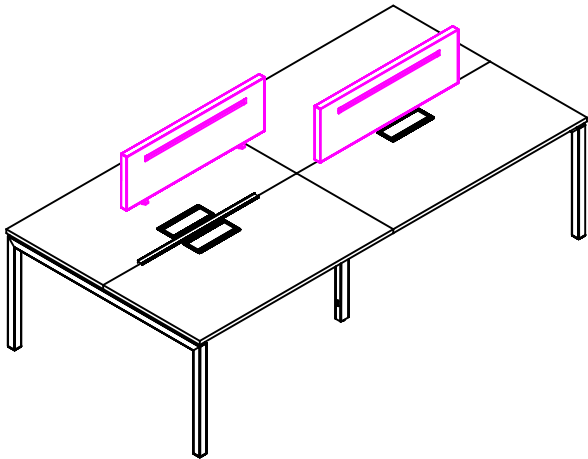

⑤

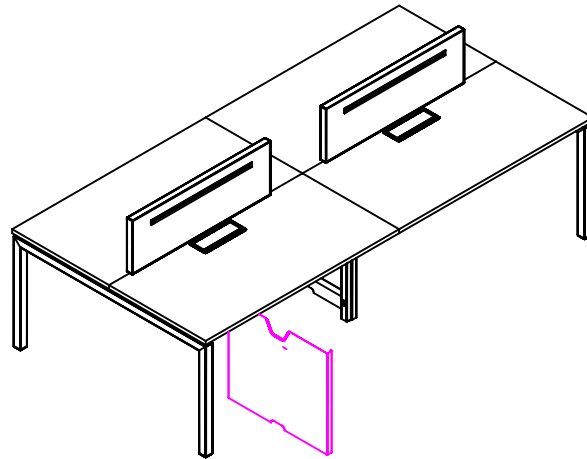

1. 钢脚/拉梁/配件连接安装

2. 面板与钢架连接

3. 安装走线系统

4. 安装桌屏

5. 安装中脚上线盖