

KL-42 会议桌 安装图

①

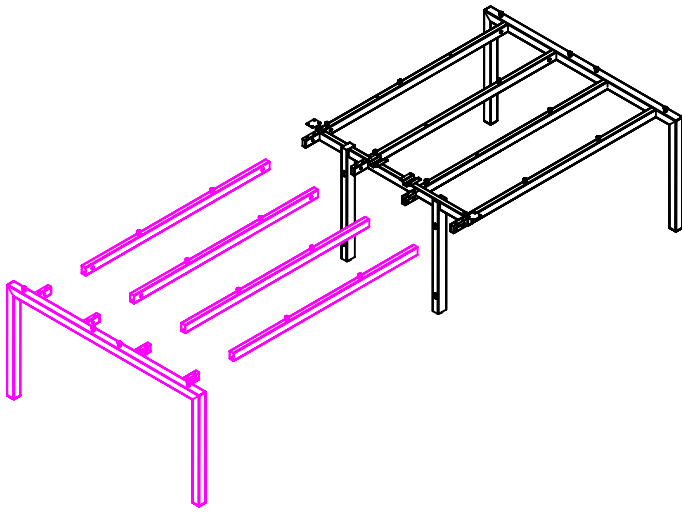

②

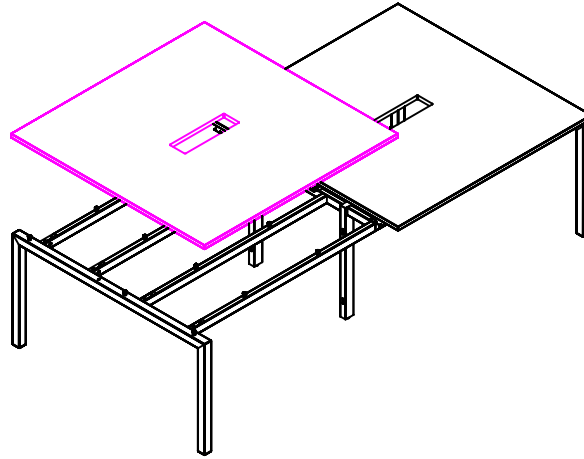

③

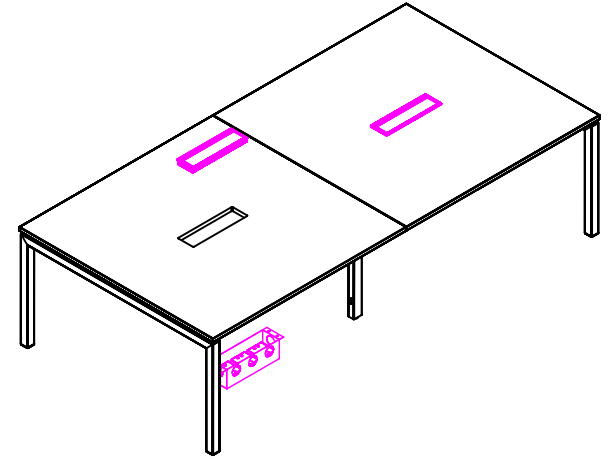

④

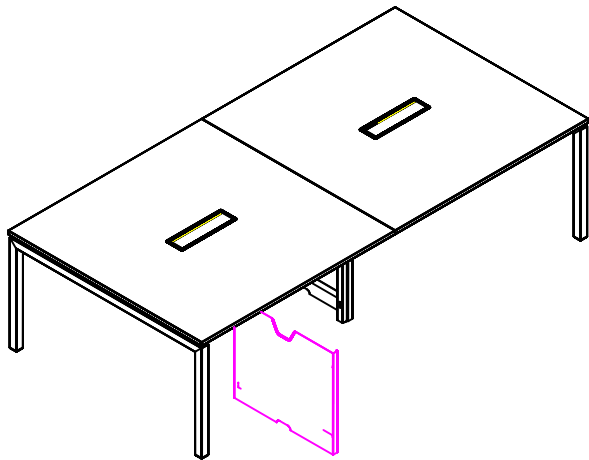

⑤

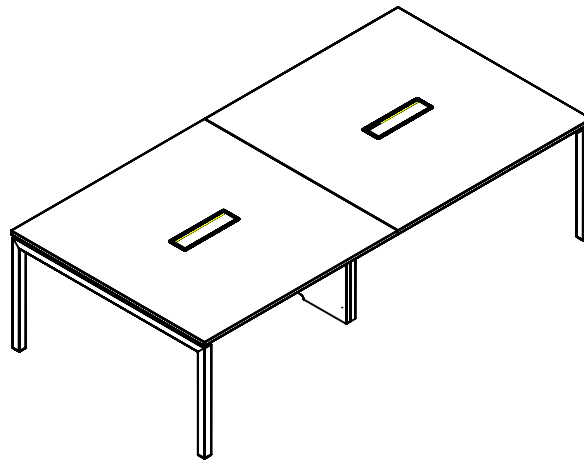

1. 钢脚/拉梁/配件
连接安装
2. 面板与钢架连接
3. 安装走线系统
4. 安装中脚上线盖